



Honeywell

Installation Guide

VisionPRO® TH8000 Series

Touch-screen Programmable Thermostat

This manual covers the following models

- TH8110U: For 1 Heat/1 Cool systems
- TH8320U: For up to 3 Heat/2 Cool systems
- TH8321U: For up to 3 Heat/2 Cool systems with dehumidification

(Pull thermostat from wallplate and turn over to find model number)

System Types

- Gas, oil, or electric heat with air conditioning
- Warm air, hot water, high efficiency furnaces, heat pumps, steam, gravity
- Heat only — two-wire systems, power to open and close zone valves (Series 20), and normally open zone valves
- Heat only with fan
- Cool only
- 750 mV heating systems

This thermostat contains a Lithium battery which may contain Perchlorate material. Perchlorate Material—special handling may apply, See www.dtsc.ca.gov/hazardouswaste/perchlorate

Need Help?

For assistance with this product please visit <http://customer.honeywell.com> or call Honeywell Customer Care toll-free at **1-800-468-1502**



Wallplate installation

1. Separate wallplate from thermostat.
2. Mount wallplate as shown below.

Grasp top and bottom of wallplate and pull to remove from thermostat.

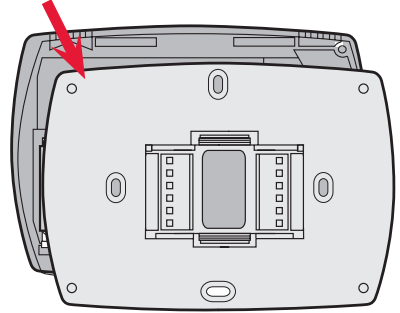

Drill 3/16" holes for drywall.
Drill 7/32" holes for plaster.

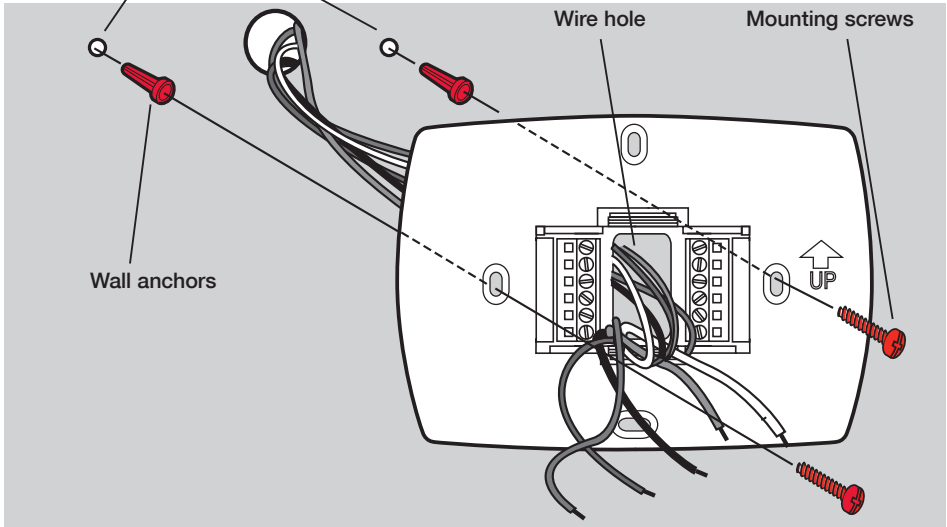

Must be installed by a trained, experienced technician

- Read these instructions carefully. Failure to follow these instructions can damage the product or cause a hazardous condition.



CAUTION: ELECTRICAL HAZARD

Can cause electrical shock or equipment damage. Disconnect power before beginning installation.



MERCURY NOTICE

If this product is replacing a control that contains mercury in a sealed tube, do not place the old control in the trash. Contact your local waste management authority for instructions regarding recycling and proper disposal.

Power options

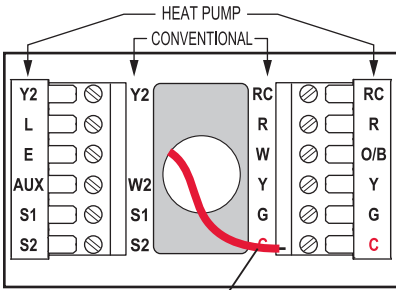

For 24VAC primary power, connect common side of transformer to “C” terminal.

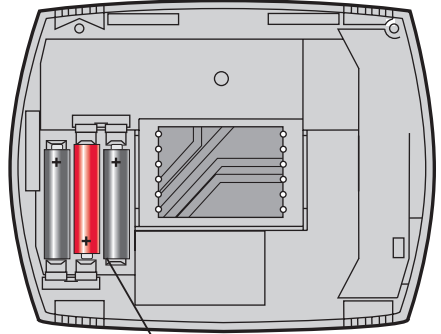

MCR29482

Insert supplied batteries for primary or backup power.

Wiring

Remove factory-installed jumper only for two-transformer systems.

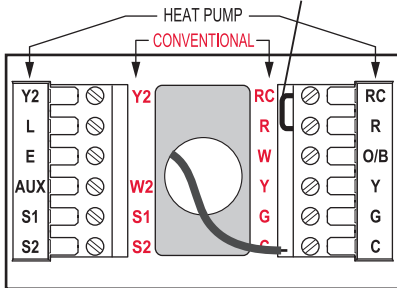

Push excess wire back into the wall opening. Plug wall opening with non-flammable insulation.

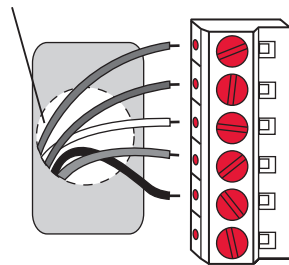

MCR29483

Terminal Designations Shaded areas below apply only to TH8320/TH8321.

Conventional Terminal Letters:

- R** Heating power. Connect to secondary side of heating system transformer.
- Rc** Cooling power. Connect to secondary side of cooling system transformer.
- C** Common wire from secondary side of cooling transformer (if 2 transformers).
- W** 1st stage heat relay.
- W2** 2nd stage heat relay.
- Y** 1st stage compressor contactor.
- Y2** 2nd stage compressor contactor.
- G** Fan relay.
- S1** Optional outdoor or remote sensor.
- S2** Optional outdoor or remote sensor.

Heat Pump Terminal Letters:

- R** Heating power. Connect to secondary side of heating system transformer.
- Rc** Cooling power. Connect to secondary side of cooling system transformer.
- C** Common wire from secondary side of cooling system transformer.
- Y** 1st stage compressor contactor.
- Y2** 2nd stage compressor contactor.
- Aux** Auxiliary heat relay.
- E** Fan relay.
- G** Emergency heat relay.
- L** Heat pump reset (powered continuously when System is set to Em Heat; system monitor when set to Heat, Cool or Off).
- O/B** Changeover valve for heat pumps.
- S1** Optional outdoor or remote sensor.
- S2** Optional outdoor or remote sensor.

Wiring

Wiring guide—conventional systems

Shaded areas below apply only to TH8320/TH8321.

1H/1C System (1 transformer)

Rc	Power [1]
R	[R+Rc joined by jumper]
W	Heat relay
Y	Compressor contactor
G	Fan relay
C	24VAC common [3]
S1	Optional outdoor/remote sensor
S2	Optional outdoor/remote sensor

Heat Only System

Rc	Power [1]
R	[R+Rc joined by jumper]
W	Heat relay
C	24VAC common [3]
S1	Optional outdoor/remote sensor
S2	Optional outdoor/remote sensor

Heat Only System (Series 20)

Rc	[R+Rc joined by jumper]
R	Series 20 valve terminal "R" [1]
W	Series 20 valve terminal "B"
Y	Series 20 valve terminal "W"
C	24VAC common [3]
S1	Optional outdoor/remote sensor
S2	Optional outdoor/remote sensor

2H/2C System (1 transformer)

Y2	Cool relay 2
W2	Heat relay 2
Rc	Power [1]
R	[R+Rc joined by jumper]
W	Heat relay 1
Y	Cool relay 1
G	Fan relay
C	24VAC common [3]
S1	Optional outdoor/remote sensor
S2	Optional outdoor/remote sensor

1H/1C System (2 transformers)

Rc	Power (cooling transformer) [1, 2]
R	Power (heating transformer) [1, 2]
W	Heat relay
Y	Compressor contactor
G	Fan relay
C	24VAC common [3, 4]
S1	Optional outdoor/remote sensor
S2	Optional outdoor/remote sensor

Heat Only System With Fan

Rc	Power [1]
R	[R+Rc joined by jumper]
W	Heat relay
G	Fan relay
C	24VAC common [3]
S1	Optional outdoor/remote sensor
S2	Optional outdoor/remote sensor

Cool Only System

Rc	Power [1]
R	[R+Rc joined by jumper]
Y	Compressor contactor
G	Fan relay
C	24VAC common [3]
S1	Optional outdoor/remote sensor
S2	Optional outdoor/remote sensor

2H/2C System (2 transformers)

Y2	Cool relay 2
W2	Heat relay 2
Rc	Power (cooling transformer) [1, 2]
R	Power (heating transformer) [1, 2]
W	Heat relay 1
Y	Cool relay 1
G	Fan relay
C	24VAC common [3, 4]
S1	Optional outdoor/remote sensor
S2	Optional outdoor/remote sensor

See [notes] below

- [1] Power supply. Provide disconnect means and overload protection as required.
- [2] Remove jumper for 2-transformer systems.
- [3] Optional 24VAC common connection.
- [4] Common connection must come from cooling transformer.

Wiring

Wiring guide—heat pump systems

Shaded areas below apply only to TH8320/TH8321.

1H/1C Heat Pump (no auxiliary heat)

Rc	Power [1]
R	[R+Rc joined by jumper]
O/B	Changeover valve [5]
Y	Compressor relay
G	Fan relay
C	24VAC common [3]
S1	Optional outdoor/remote sensor
S2	Optional outdoor/remote sensor

2H/1C Heat Pump (with auxiliary heat)

L	Equipment monitor [6, 7]
E	Emergency heat relay [8]
Aux	Auxiliary heat relay (Heat 2) [8]
Rc	Power [1]
R	[R+Rc joined by jumper]
O/B	Changeover valve [5]
Y	Compressor relay
G	Fan relay
C	24VAC common [3]
S1	Optional outdoor/remote sensor
S2	Optional outdoor/remote sensor

2H/2C Heat Pump (no auxiliary heat)

Y2	Compressor 2 relay
Rc	Power [1]
R	[R+Rc joined by jumper]
O/B	Changeover valve [5]
Y	Compressor 1 relay
G	Fan relay
C	24VAC common [3]
S1	Optional outdoor/remote sensor
S2	Optional outdoor/remote sensor

3H/2C Heat Pump (with auxiliary heat)

Y2	Compressor 2 relay
L	Equipment monitor [6, 7]
E	Emergency heat relay [8]
Aux	Auxiliary heat relay (Heat 2) [8]
Rc	Power [1]
R	[R+Rc joined by jumper]
O/B	Changeover valve [5]
Y	Compressor 1 relay
G	Fan relay
C	24VAC common [3]
S1	Optional outdoor/remote sensor
S2	Optional outdoor/remote sensor

See [notes] below

- [1] Power supply. Provide disconnect means and overload protection as required.
- [3] Optional 24VAC common connection.
- [5] **O/B** set to control as either **O** or **B** in installer setup.
- [6] If **L** terminal is used, 24VAC common (terminal C) must be connected.
- [7] Heat pump reset (powered continuously when thermostat is set to Em. Heat; system monitor when set to Heat, Cool, or Off).
- [8] Install field jumper between **Aux** and **E** terminals if there is no emergency heat relay.

Remove tab and mount thermostat

Remove tab.

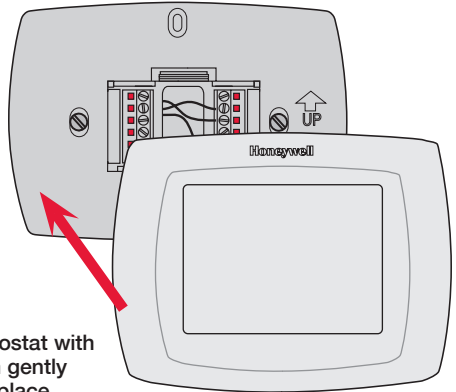
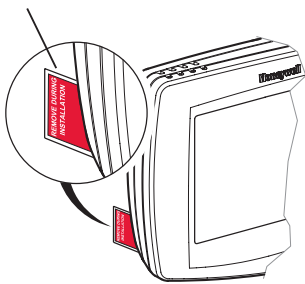

Align pins on back of thermostat with slots in wallplate, then push gently until thermostat snaps into place.

MCR29484

Set date and time

Press ▲▼
to set date

Press ▲▼
to set month

Press ▲▼
to set year

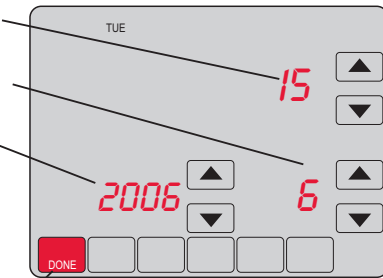

Press **DONE** to save changes.

Press ▲▼
to set time

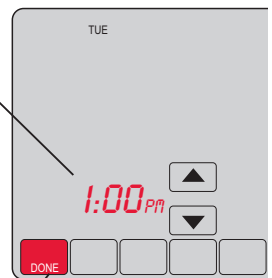

Press **DONE** to save and exit.

MCR29485

Installer setup

1. Press **SYSTEM**.

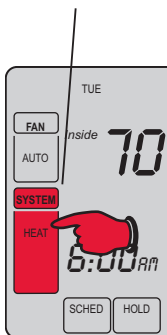

2. Press and hold these two buttons until the display changes.

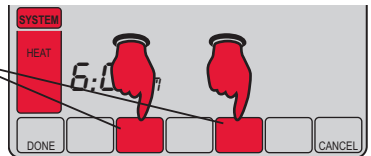

3. Change settings as required (see pages 7-9).



MCR29486

Installer setup

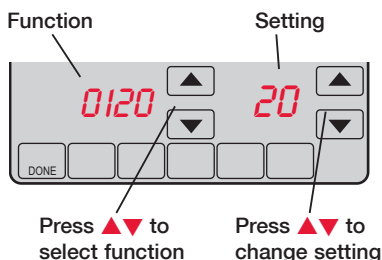

Setup functions

Settings & Options (factory default in bold)

Shaded areas below apply only to **TH8320/TH8321**.

0120	Year (first two digits)	20 (2000-2078) 21 (2101-2178)
0130	Year (second two digits)	06 (2006) [Other options: 00-99]
0140	Month	6 [Other options: 1-12]
0150	Date	15 [Other options: 1-31]
0160	Schedule format	4 7-day programming 0 Non-programmable
0170	System type	1 1 heat/1 cool conventional 2 1 heat/1 cool heat pump (no aux. heat) 3 Heat only (2-wire systems) 4 Heat only with fan 5 Hot water Series 20 system (power to open & close zone valves/normally open zone valves) 6 Cool only 7 2 heat/1 cool heat pump (with aux. heat) 8 2 heat/2 cool multistage conventional 9 2 heat/1 cool multistage conventional 10 1 heat/2 cool multistage conventional 11 2 heat/2 cool heat pump (no aux. heat) 12 3 heat/2 cool heat pump (with aux. heat)
0180	Fan control (heating)	0 Gas/Oil heat (equipment controls heating fan) 1 Electric furnace (thermostat controls heating fan)
0190	Changeover valve (O/B terminal)	0 O/B terminal controls valve in cooling 1 O/B terminal controls valve in heating
0200	Auxiliary heat	0 Electric backup heat 1 Fossil fuel backup heat
0210	External fossil fuel kit	1 External fossil fuel kit controls backup heat 0 Thermostat controls backup heat (outdoor sensor required)
0220	1st stage compressor cycle rate	3 Recommended for most compressors [Other options: 1, 2, 4, 5 or 6 CPH]
0230	2nd stage compressor cycle rate	3 Recommended for most compressors [Other options: 1, 2, 4, 5 or 6 CPH]

Continued on next page

Installer setup

Setup functions

Settings & Options (factory default in bold)

Shaded areas below apply only to **TH8320/TH8321**.

0240	First stage heat cycle rate (CPH= cycles per hour)	5 Gas or oil furnaces of less than 90% efficiency 1 Steam or gravity systems 3 Hot water systems & furnaces of 90%+ efficiency 9 Electric furnaces [Other options: 2, 4, 6, 7, 8, 10, 11, 12 CPH]
0250	Second stage heat cycle rate (CPH)	5 Gas or oil furnaces of less than 90% efficiency 1 Steam or gravity systems 3 Hot water systems & furnaces of 90%+ efficiency 9 Electric furnaces [Other options: 2, 4, 6, 7, 8, 10, 11, 12 CPH]
0260	Third stage heat cycle rate (CPH)	9 Electric auxiliary heat or electric furnaces 1 Steam or gravity systems 3 Hot water systems & furnaces of 90%+ efficiency 5 Gas or oil furnaces of less than 90% efficiency [Other options: 2, 4, 6, 7, 8, 10, 11, 12 CPH]
0270	Emergency heat cycle rate (CPH)	9 Electric emergency heat 1 Steam or gravity systems 3 Hot water systems & furnaces of 90%+ efficiency 5 Gas or oil furnaces of less than 90% efficiency [Other options: 2, 4, 6, 7, 8, 10, 11, 12 CPH]
0280	Backlight	0 Backlight on for approx. 8 seconds after keypress 1 Backlight always on low intensity, full bright after key-press (requires 24VAC connection)
0300	Manual/Auto changeover	0 Manual changeover (Heat/Cool/Off) 1 Automatic changeover (Heat/Cool/Auto/Off)
0310	Auto changeover deadband	3 Heat/cool temperature 3°F apart (1.5°C) ** See page 11 [Other options: 2-9 (2°F to 9°F/1°C to 5°C)]
0320	Temperature display	0 Fahrenheit 1 Celsius
0330	Daylight savings	2 Auto-change to daylight savings time (2007 and beyond, for areas that use the new 2007 DST calendar) 1 Auto-change to daylight savings time (through 2006, and for areas that <u>do not</u> use the new 2007 DST calendar) 0 Daylight savings time is turned off
0340	Remote sensor	0 No remote sensor 1 Outdoor sensor (display only) 2 Outdoor control sensor (select heat pumps) ** See page 11 3 Indoor sensor
0350	Heat pump compressor lockout	0 No heat pump compressor lockout [Other options: 15, 20, 25, 30, 35, 40°F (-9.5°C to 7°C)]
0360	Heat pump auxiliary lockout	0 No heat pump auxiliary lockout [Other options: 40, 45, 50, 55, 60°F (4.5°C to 15.5°C)]
0380	Dehumidification control	0 No dehumidification control 1 Thermostat controls dehumidification with air conditioner ** See page 11

Continued on next page

Installer setup

Setup functions	Settings & Options (factory default in bold)
0500 Furnace filter change reminder	0 Off 1 10-day run time (about 1 month) 2 30-day run time (about 3 months) 3 60-day run time (about 6 months) 4 90-day run time (about 9 months) 5 120-day run time (about 1 year) 6 365-day run time (about 3 years)
0510 Humidifier pad change reminder	0 Off 1 90 calendar days 2 180 calendar days 3 365 calendar days
0520 UV lamp change reminder	0 Off 1 365 calendar days
0530 Adaptive Intelligent Recovery™	1 On ** See page 11 0 Off
0540 Program periods	4 4 program periods (Wake, Leave, Return, Sleep) 2 2 program periods (Wake, Sleep)
0580 Compressor protection	5 5 minute compressor off time ** See page 11 [Other options: 0, 1, 2, 3 or 4-minute off time]
0600 Heat temperature range stop	90 Max. heat temperature setting is 90°F (32°C) [Other options: 40-89°F (4°C to 32°C)]
0610 Cool temperature range stop	50 Min. cool temperature setting is 50°F (10°C) [Other options: 51-99°F (11°C to 37°C)]
0640 Clock format	12 12-hour time (i.e., “3:30 pm”) 24 24-hour time (i.e., “15:30”)
0650 Extended fan timer (heat)	0 Off 90 Fan runs for 90 seconds after call for heat ends
0660 Extended fan timer (cool)	0 Off 90 Fan runs for 90 seconds after call for cooling ends
0670 Keypad lock	0 Keypad unlocked (fully functional) 1 Partially locked (access to temperature settings only) 2 Fully locked
0680 Heat temperature control	2 Standard temperature control (recommended) 1 Choose if room is warmer than set temperature 3 Choose if room does not reach set temperature
0690 Cool temperature control	2 Standard temperature control (recommended) 1 Choose if room is cooler than set temperature 3 Choose if room does not reach set temperature
0700 Temperature display offset	0 Thermostat displays actual room temperature [Other options: -3, -2, -1, 1, 2, 3°F offset (-1.5°C to 1.5°C)]
0710 RESET	0 No reset 1 Reset installer options & program schedule to factory default (only date and time settings are retained)

Installer system test

During installer setup, press ▼ repeatedly until “Test” appears.

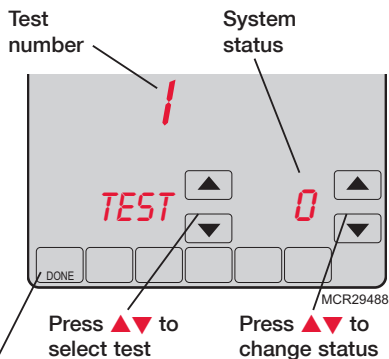
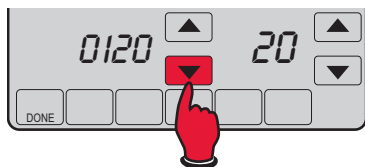

Press **DONE** to terminate testing.

Press ▲▼ to select test

Press ▲▼ to change status

Shaded areas below apply only to **TH8320/TH8321**.

System test

System status

1 Cooling system

- 0 Compressor and fan turn off
- 1 Compressor and fan turn on
- 2 Second stage compressor turns on

2 Fan system

- 0 Fan turns off
- 1 Fan turns on

3 Heating system

- 0 Heat and fan turn off
- 1 Heat turns on (fan on if Function 0170 is set for heat pump, or if Function 0180 is set to “1”) ** See page 6
- 2 Second stage heat turns on
- 3 Third stage heat turns on

4 Emergency heating system

- 0 Heat and fan turn off
- 1 Heat and fan turn on
- 2 Second stage heat turns on (Auxiliary heat)]



CAUTION: EQUIPMENT DAMAGE HAZARD. Compressor protection is bypassed during testing. To prevent equipment damage, avoid cycling the compressor quickly.

Special functions

Shaded areas below apply only to **TH8320/TH8321**.

Auto Changeover (Setup Function 0300): When set to Auto, the thermostat automatically selects heating or cooling depending on the indoor temperature. Heat and cool settings must be at least 2 degrees apart. If function 0380 is set to On, the heat and cool settings must be at least 5 degrees apart.

Remote Sensor (Setup Function 0340): If an optional outdoor sensor is installed, the thermostat can display the outside temperature. If an optional remote indoor sensor is installed, the thermostat will display the temperature at the sensor location (the internal sensor in the thermostat is not used).

Adaptive Intelligent Recovery (Setup Function 0530): Allows the thermostat to “learn” how long the furnace and air conditioner take to reach programmed temperature settings, so the temperature is reached at the scheduled time.

Compressor Protection (Setup Function 0580): Forces the compressor to wait a few minutes before restarting, to prevent damage. During this time, the message “Wait” flashes on the display.

Dehumidification control (Setup Function 0380): TH8321 models monitor the indoor humidity level and automatically activate the cooling system to reduce humidity by lowering the temperature by up to 3 degrees below the current cool setting.

Heat Pump Temperature Lockout (with fossil-fuel backup): If the thermostat is installed with an optional outdoor sensor, you can select a compressor lockout temperature (Function 0350). When the outdoor temperature is below the lockout temperature, only the auxiliary heat operates. When the outdoor temperature is above the lockout temperature, only the compressor operates.

Heat Pump Temperature Lockouts (with electric heat backup): If the thermostat is installed with an optional outdoor sensor, you can select a compressor lockout temperature (Function 0350) and/or an auxiliary heat lockout temperature (Function 0360). When the outdoor temperature is below the compressor lockout temperature, only the auxiliary heat operates. When the outdoor temperature is above the auxiliary lockout temperature, only the compressor operates. If the outdoor temperature is between the compressor and auxiliary lockout temperatures, both the compressor and auxiliary heat can operate.

Accessories & replacement parts

Please contact your distributor to order replacement parts.

Outdoor temperature sensor Part Number C7089U1006

Remote indoor temperature sensor Part Number C7189U1005

Cover plate* Part Number 32003796-001

*(Use to cover marks left by old thermostats.)

Specifications

Temperature Ranges

- Heat: 40° to 90°F (4.5° to 32°C)
- Cool: 50° to 99°F (10° to 37°C)

Operating Ambient Temperature

- 0° to 120°F (-18° to 48.9°C)

Shipping Temperature

- -30° to 150°F (-34° to 66°C)

Operating Relative Humidity

- 5% to 90% (non-condensing)

Physical Dimensions

- 4-9/16" H x 6" W x 1-3/8" D
- 116 mm H x 152 mm W x 35 mm D

Electrical Ratings

Terminal	Voltage (50/60Hz)	Running Current
W Heating (Powerpile)	20-30 Vac 750 mV DC	0.02-1.0 A 100 mA DC
W2 Heating	20-30 Vac	0.02-0.6 A
Y Cooling	20-30 Vac	0.02-1.0 A
Y2 Cooling	20-30 Vac	0.02-0.6 A
Aux Auxiliary heat	20-30 Vac	0.02-1.0 A
O/B Changeover	20-30 Vac	0.02-0.6 A
E Emergency heat	20-30 Vac	0.02-1.0 A
L Heat pump reset	20-30 Vac	0.02-0.6 A

Need Help?

For assistance with this product please visit <http://customer.honeywell.com> or call Honeywell Customer Care toll-free at **1-800-468-1502**

Automation and Control Solutions

Honeywell International Inc.
1985 Douglas Drive North
Golden Valley, MN 55422

Honeywell Limited-Honeywell Limitée
35 Dynamic Drive
Toronto, Ontario M1V 4Z9

<http://customer.honeywell.com>



Printed in U.S.A. on recycled paper containing at least 10% post-consumer paper fibers.

© U.S. Registered Trademark.
US Patent No. 6595430, D509151 and other patents pending.
© 2009 Honeywell International Inc.
69-1896—01 M.S. 05-09

Honeywell